

Garage 4,2x5,95+carport 3x5,95-44

Boarding joist plan
Trummplan
Lamborde plan

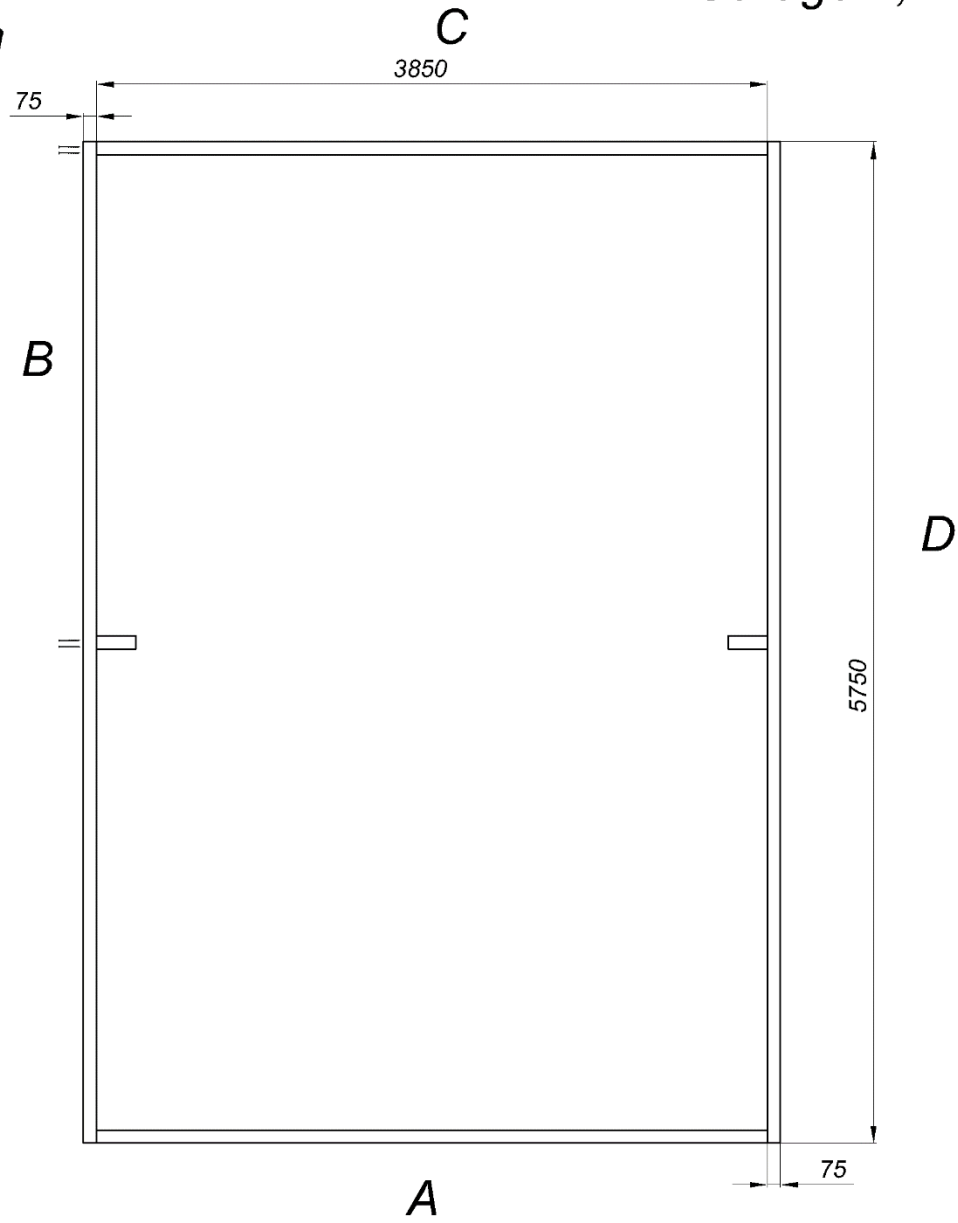

Garage 4,2x5,95+carport 3x5,95-44

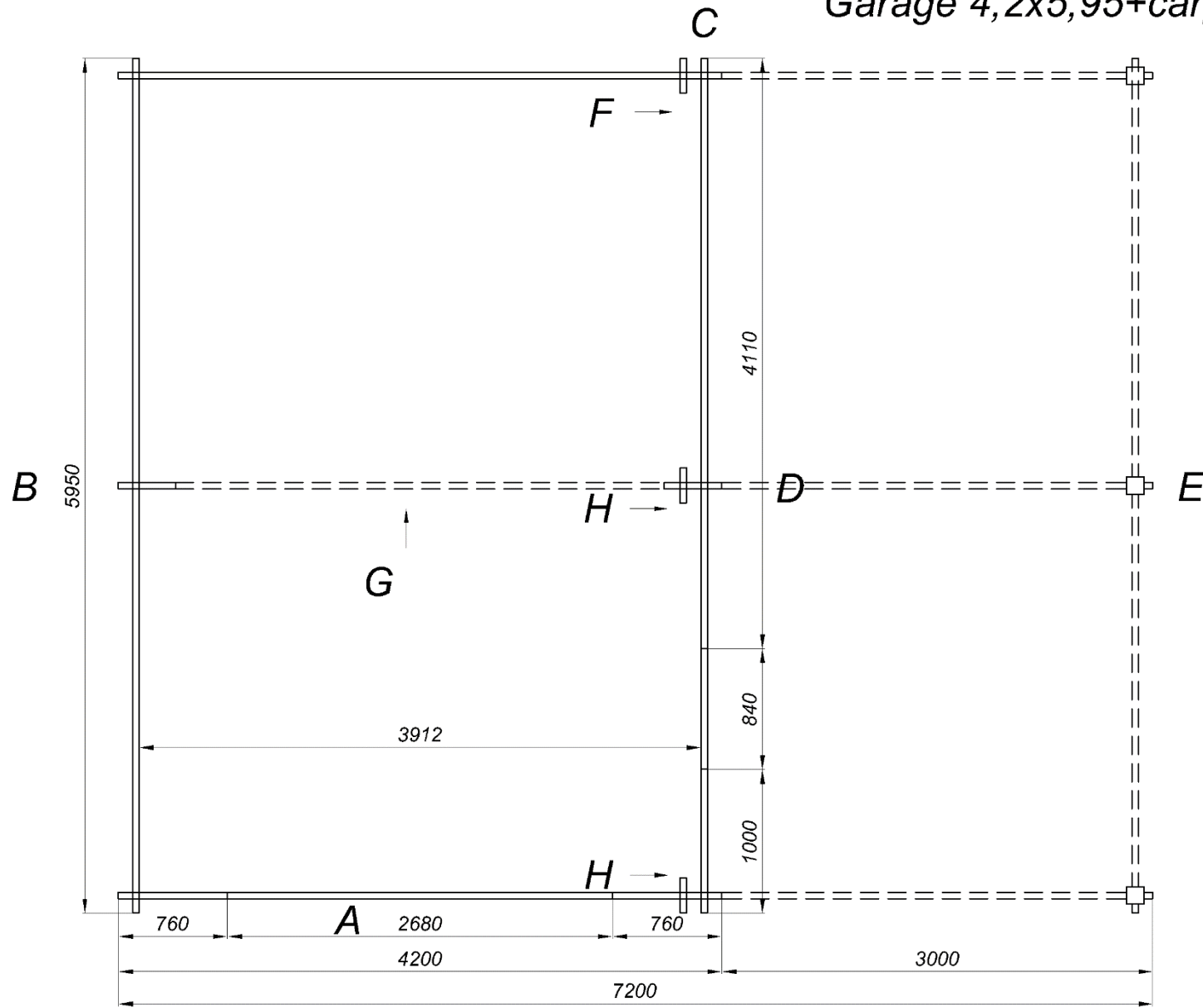

Garage 4,2x5,95+carport 3x5,95-44

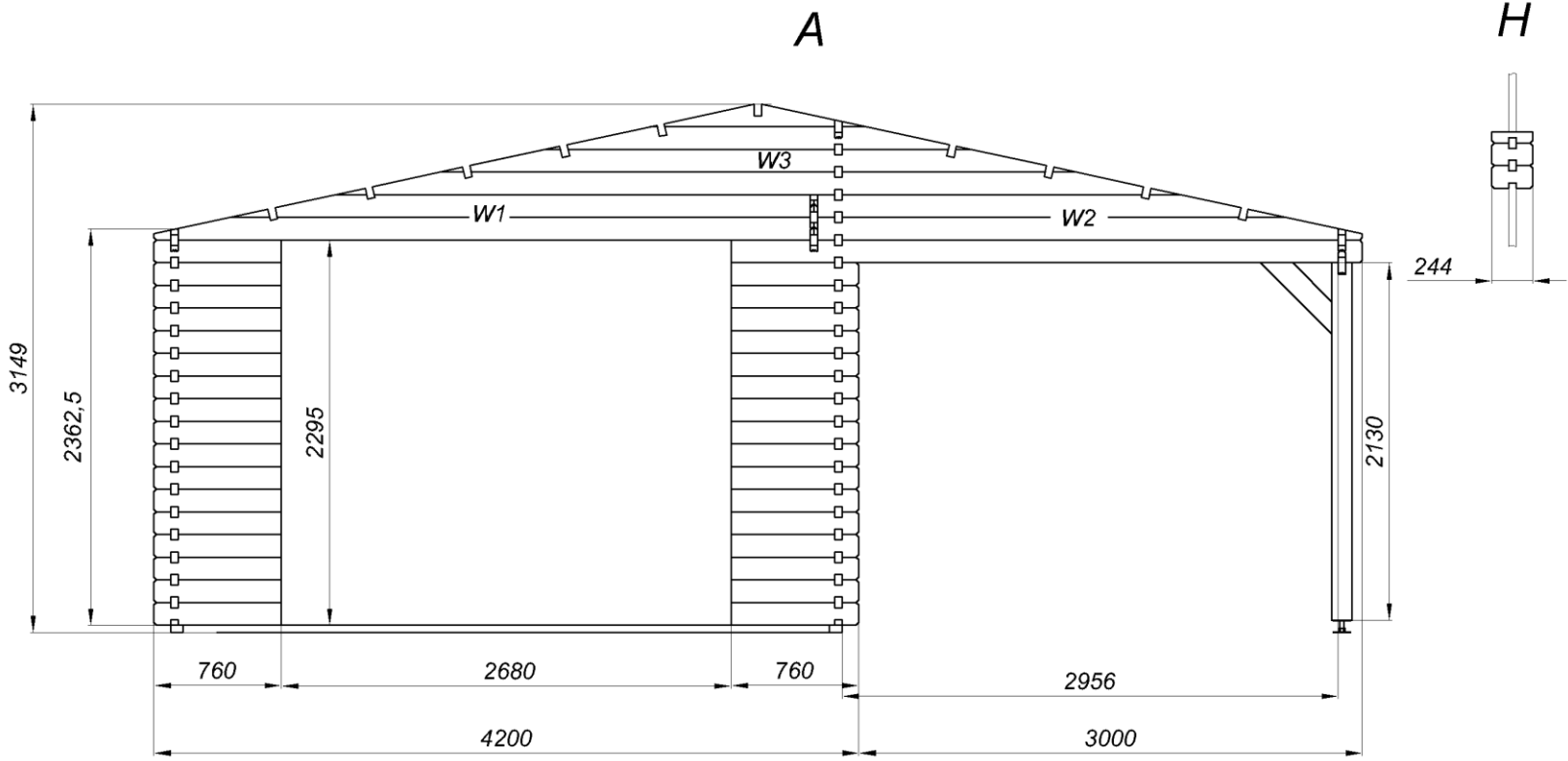

Garage 4,2x5,95+carport 3x5,95-44

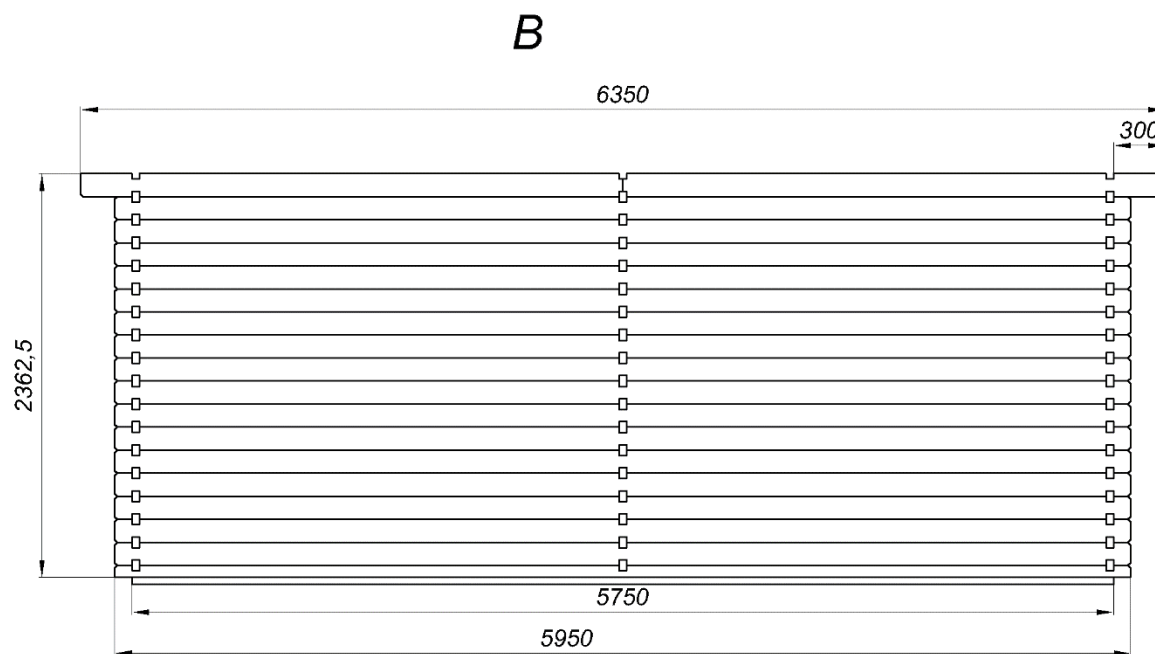

Garage 4,2x5,95+carport 3x5,95-44

C

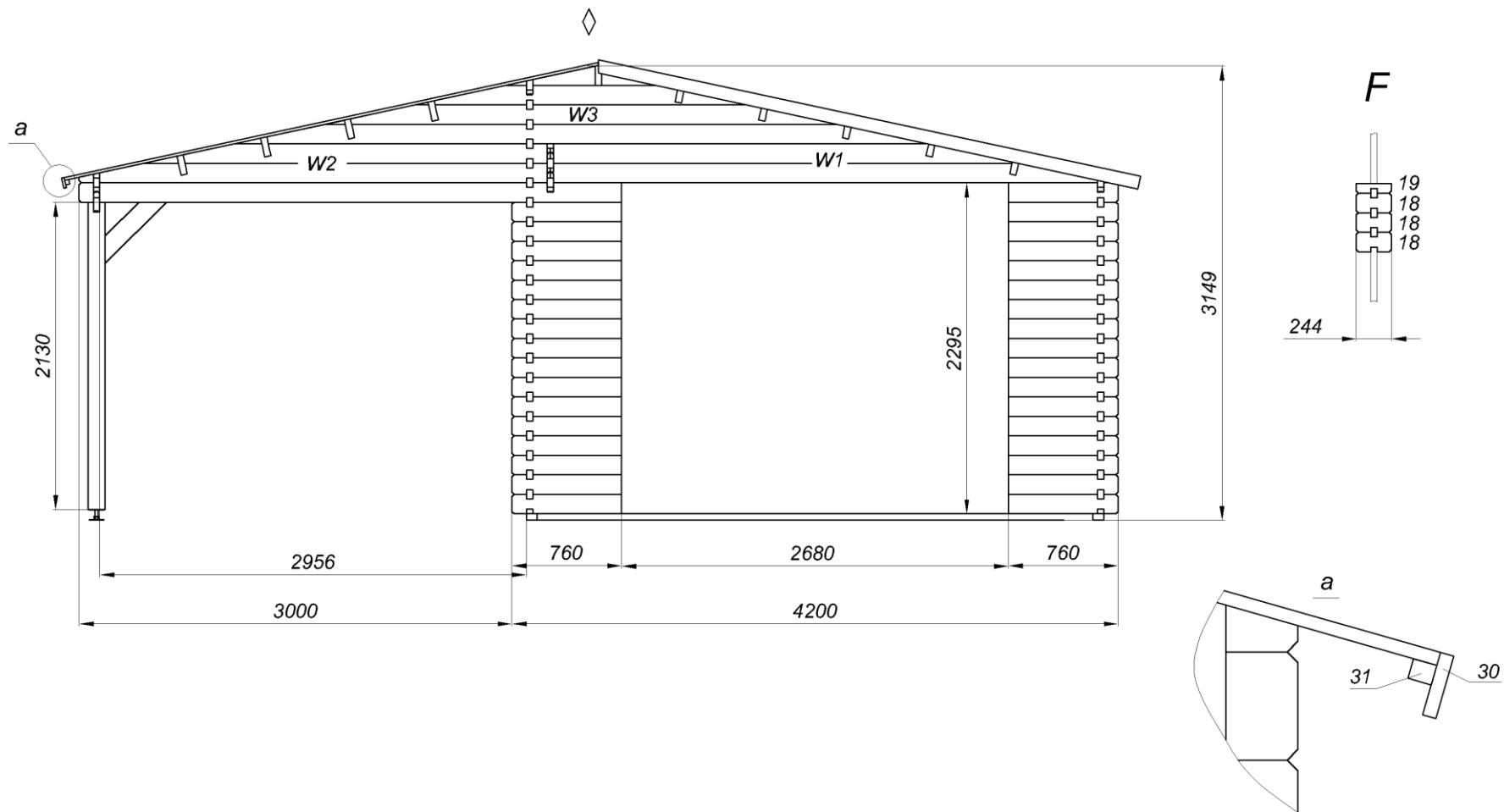

Garage 4,2x5,95+carport 3x5,95-44

D

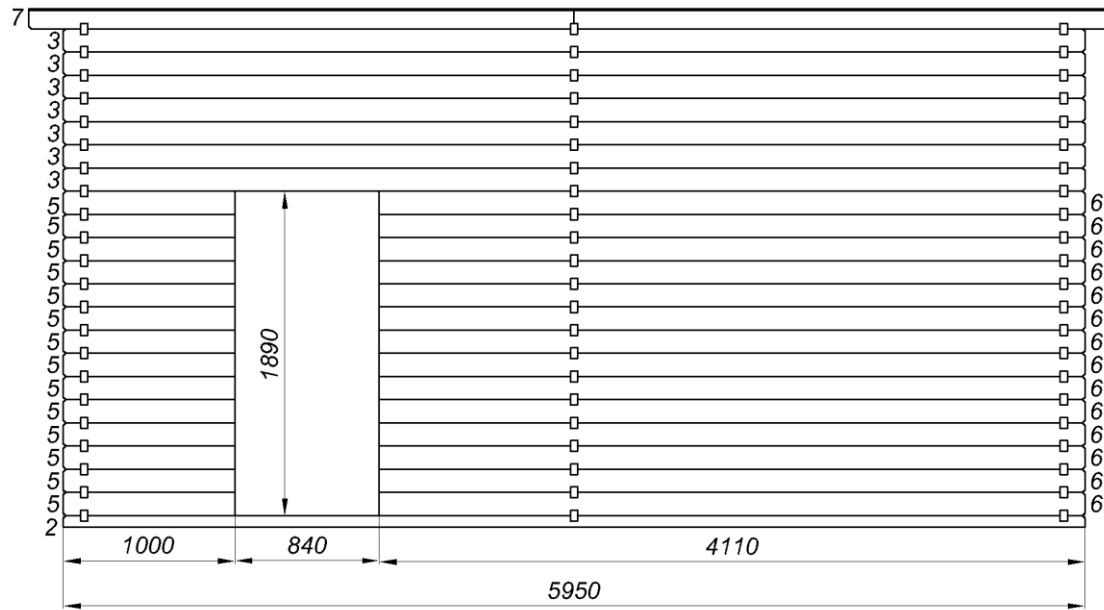

Garage 4,2x5,95+carport 3x5,95-44

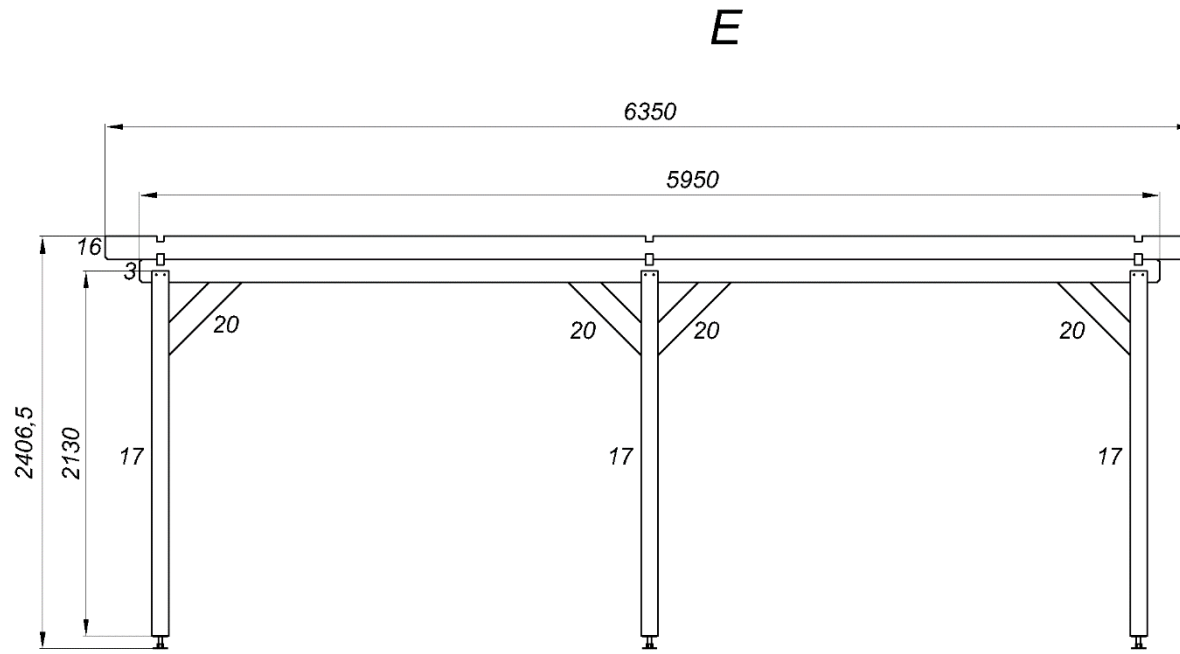

Garage 4,2x5,95+carport 3x5,95-44

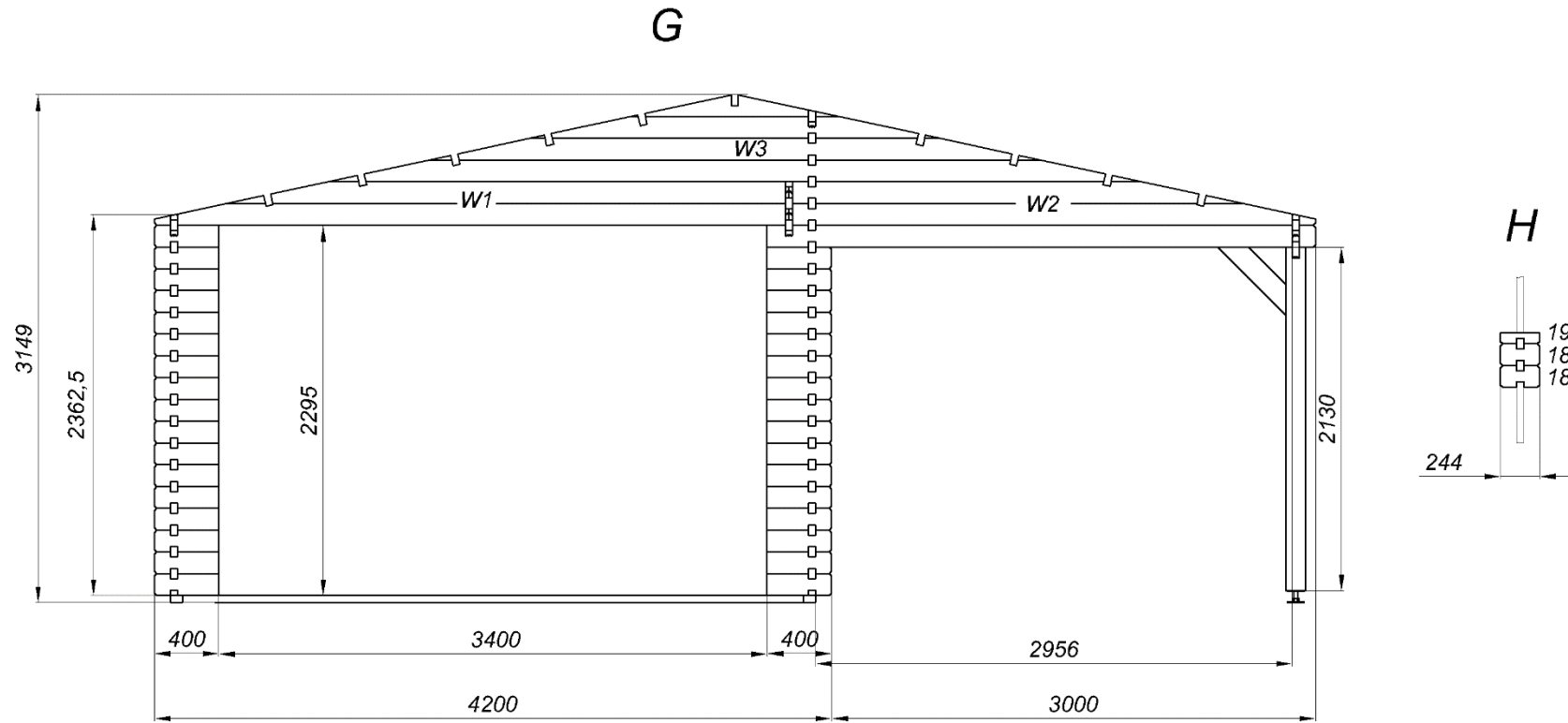

Garage 4,2x5,95+carport 3x5,95-44

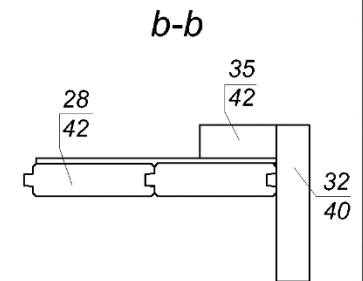
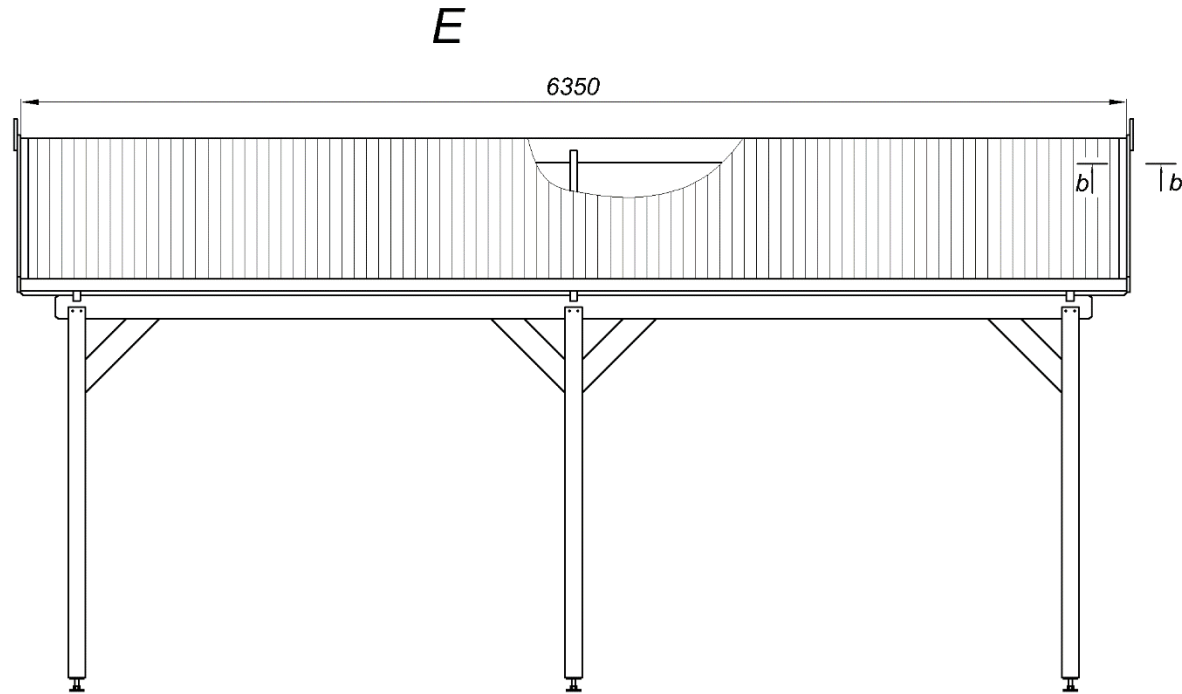

Garage 4x5,95+carport 3x5,95-44

Vue exterieure
View from outside

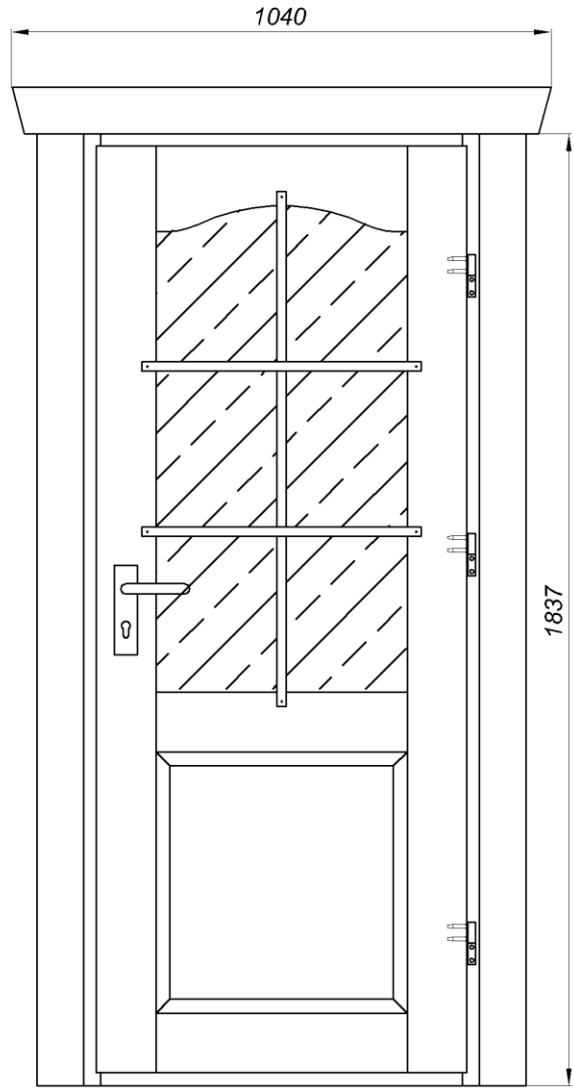

Voir l'interieur
Inside view

