



CASSETTA IN LEGNO

2,8x2,8 (est. 3x3)

Spessore 34mm

DISEGNI TECNICI

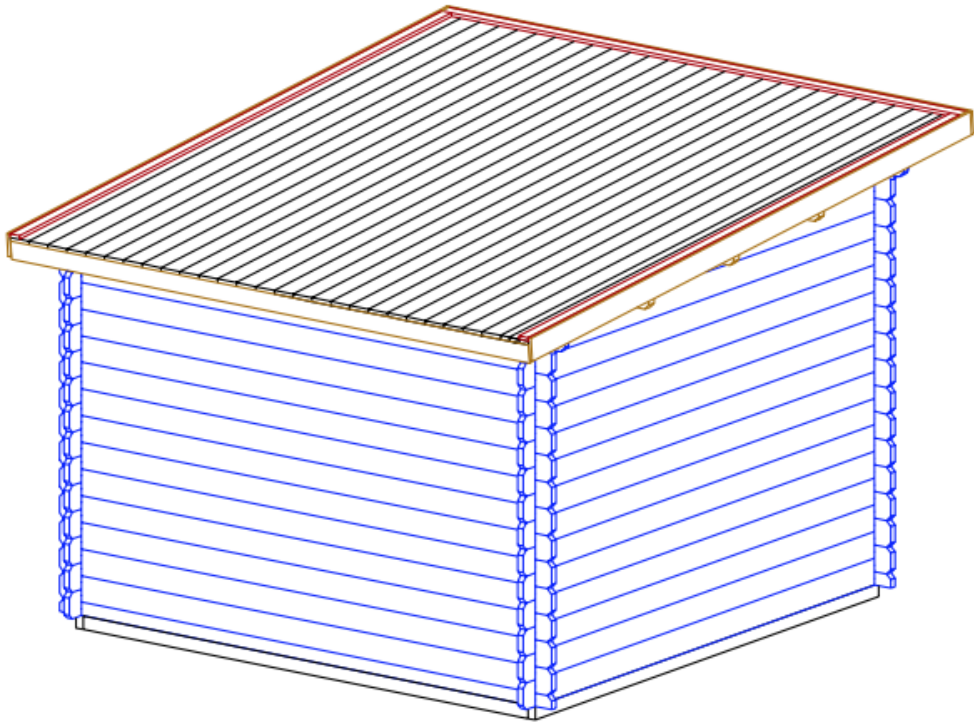
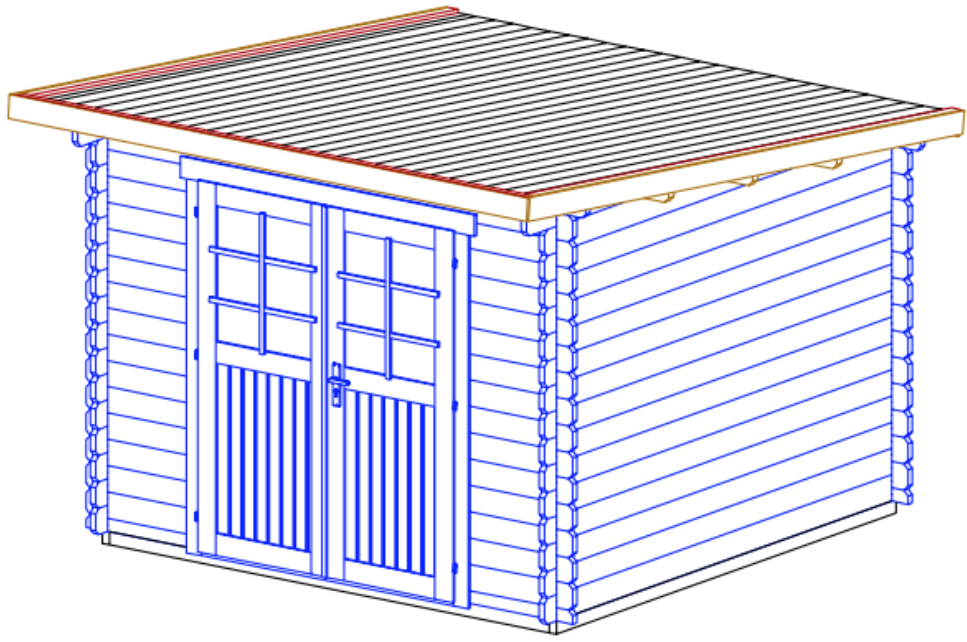

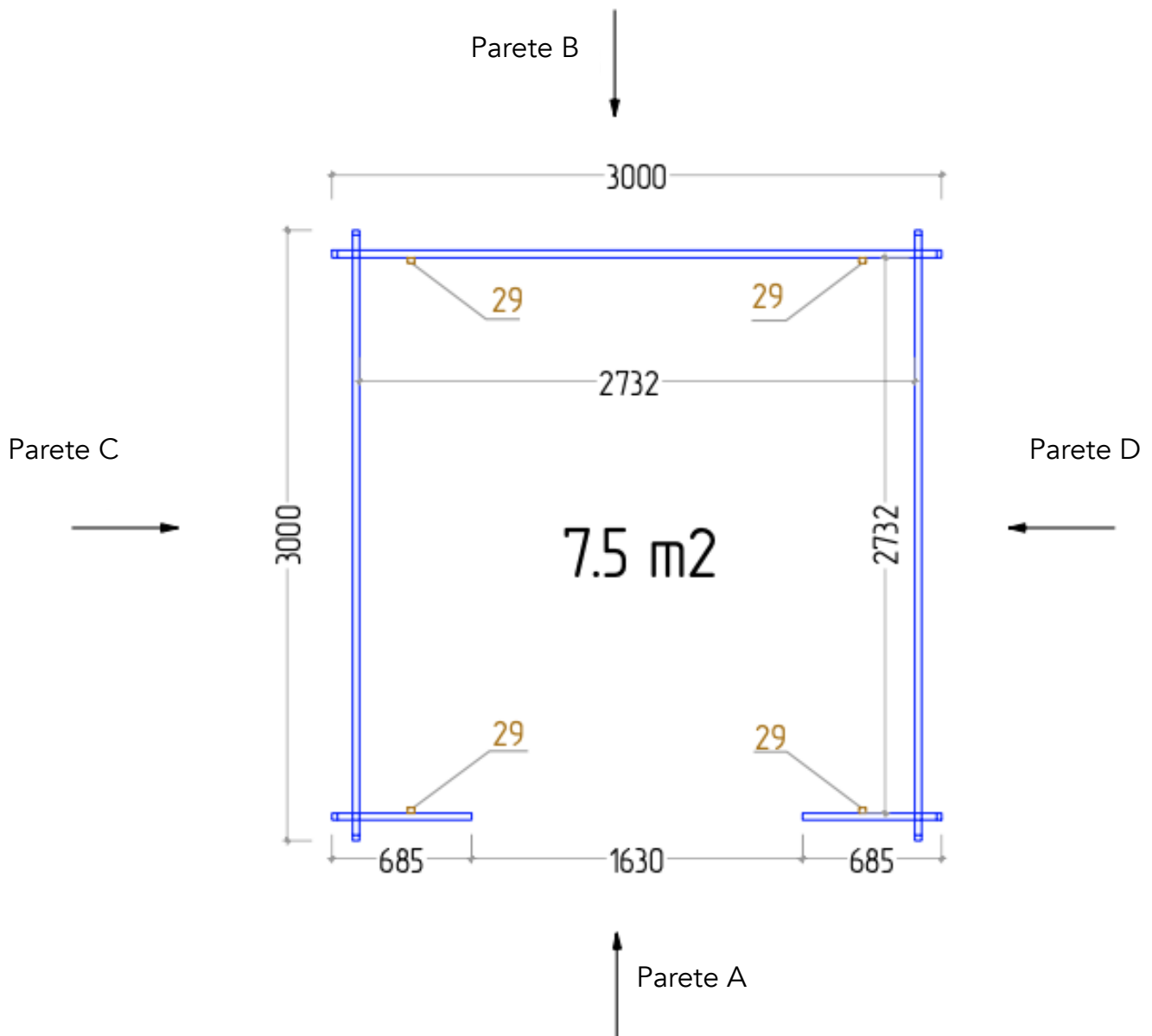

Altezza minima: 205cm
Altezza massima: 240cm
(comprensiva di travetti e tetto)

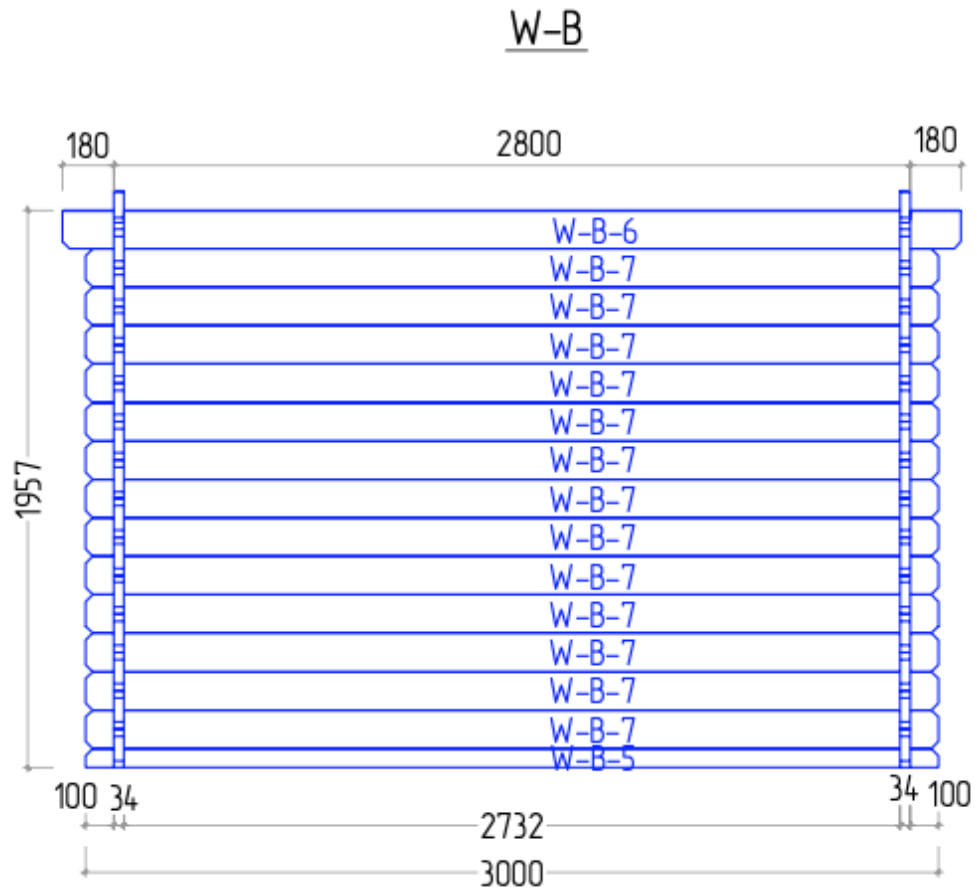
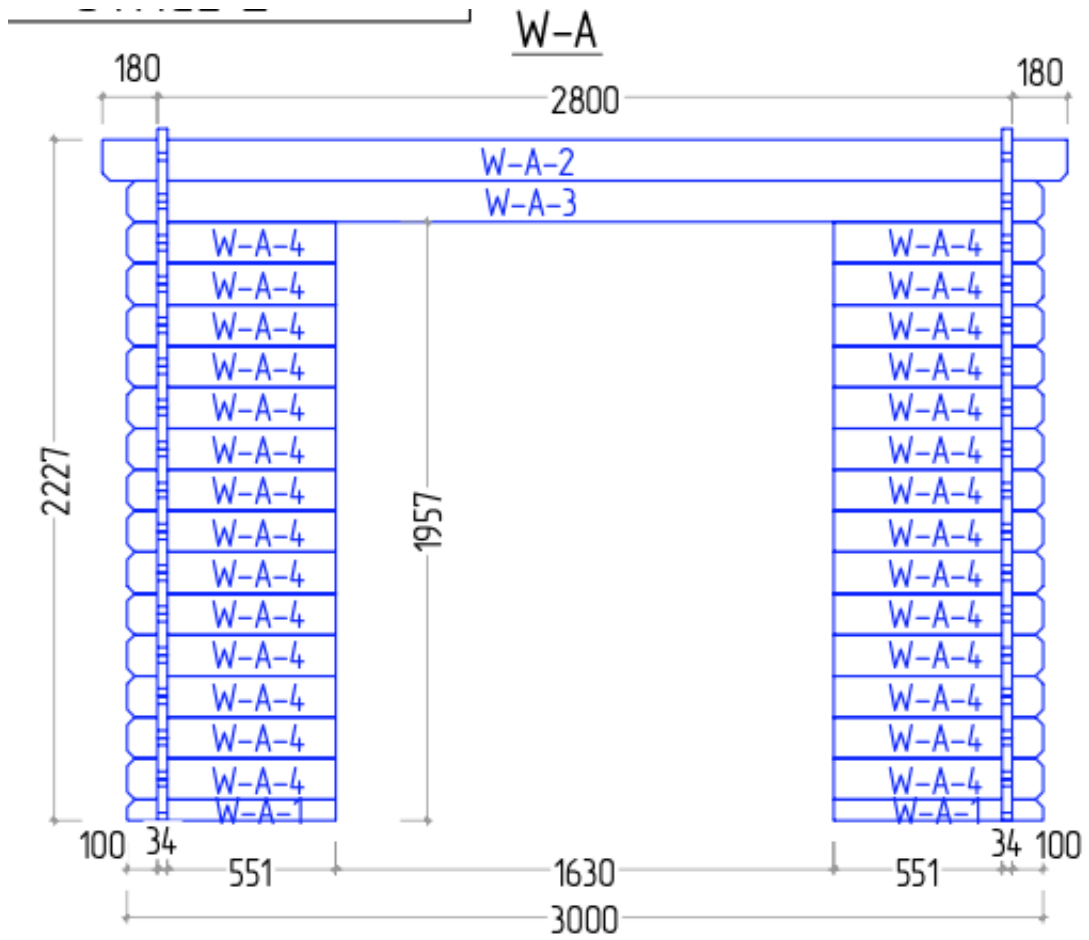

STAGE 2

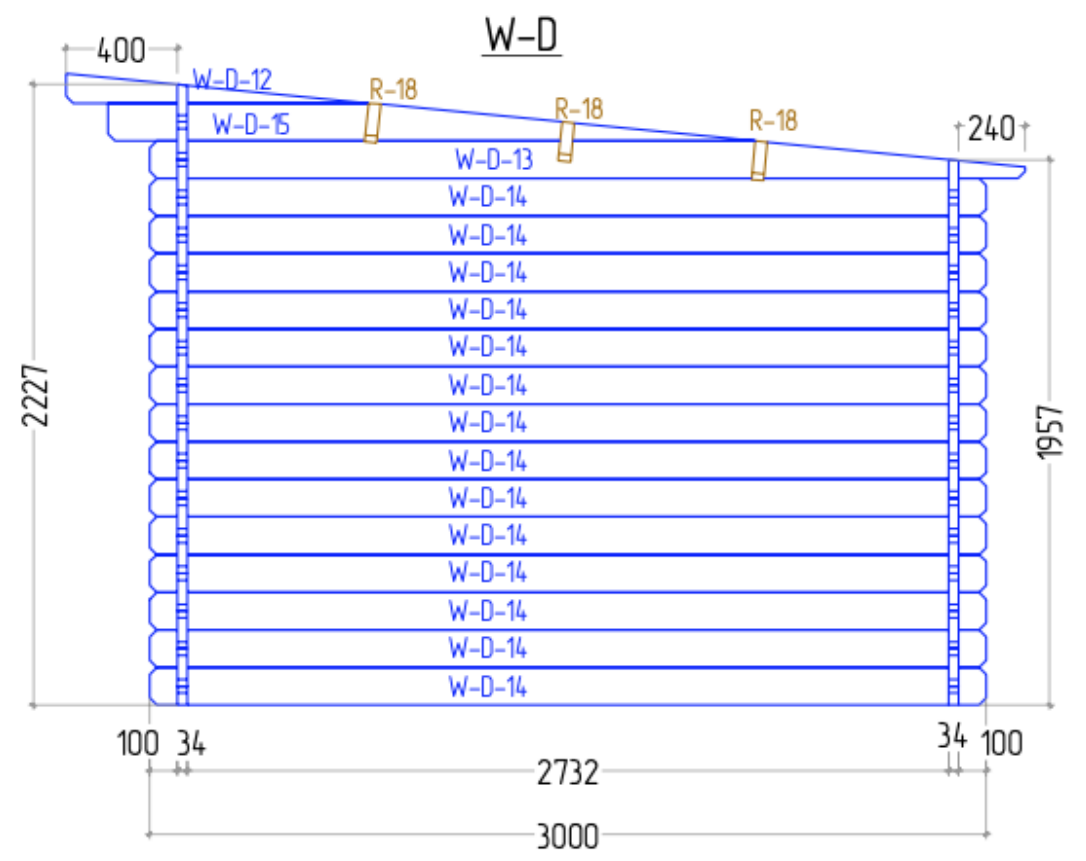
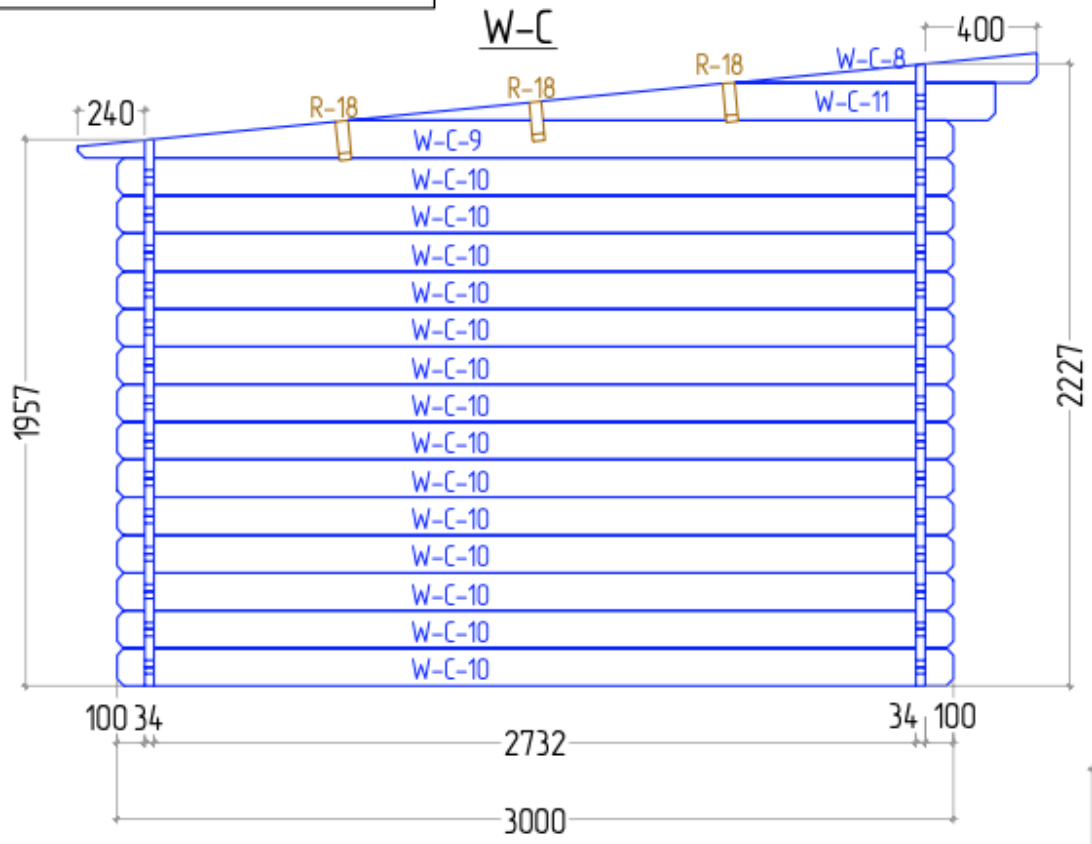

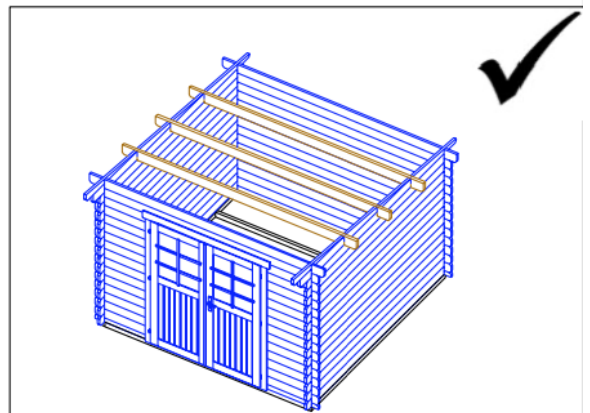
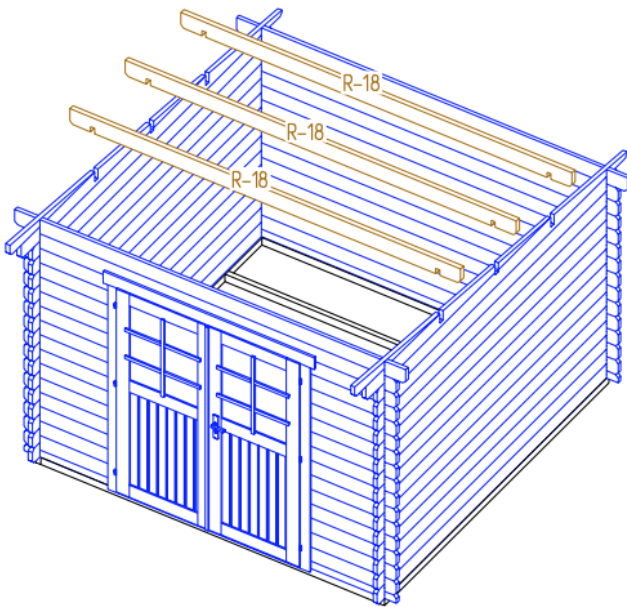
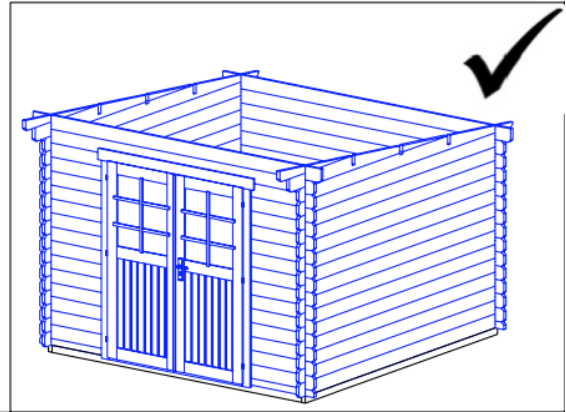
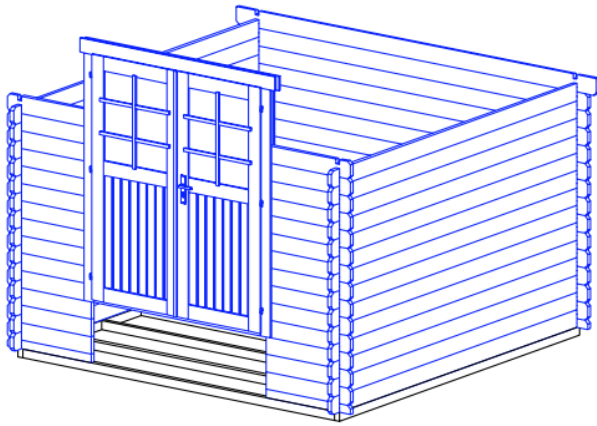

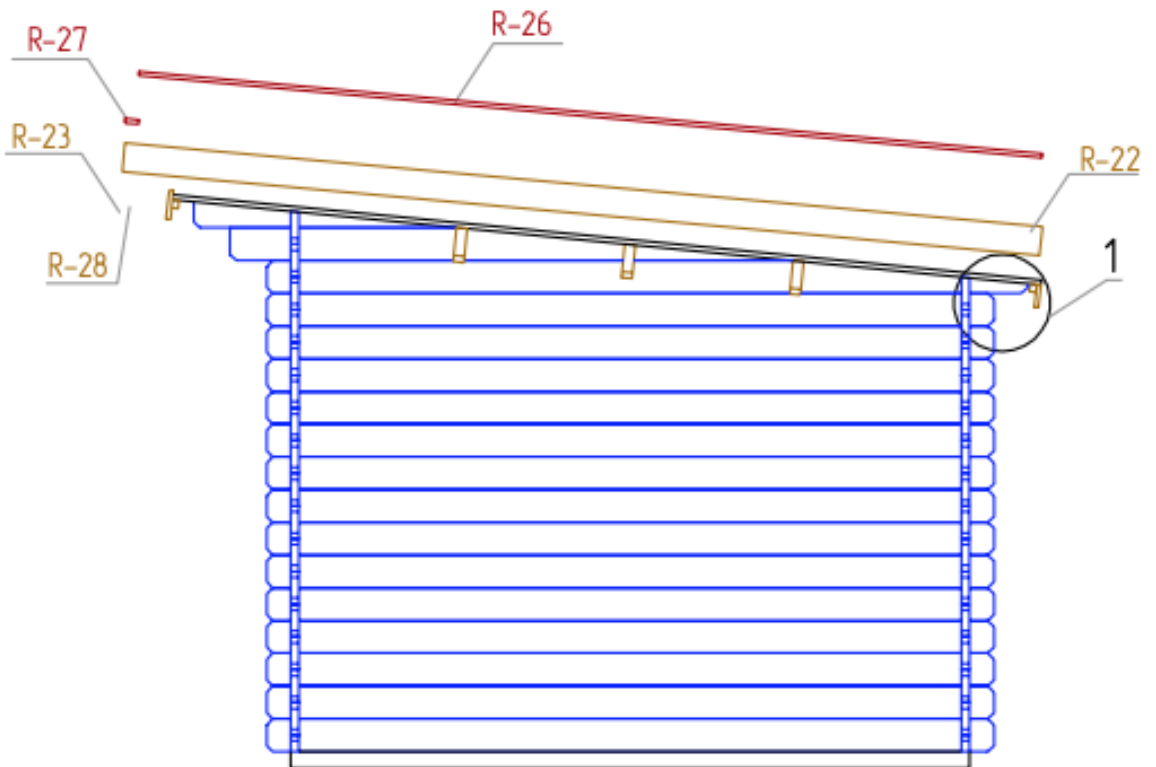
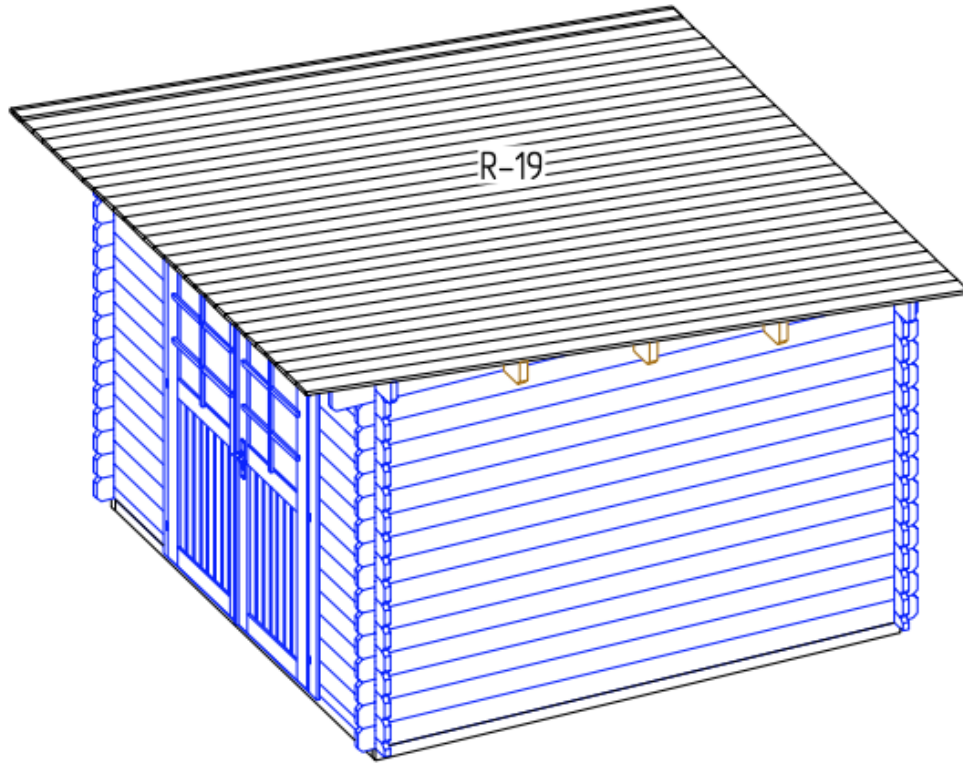

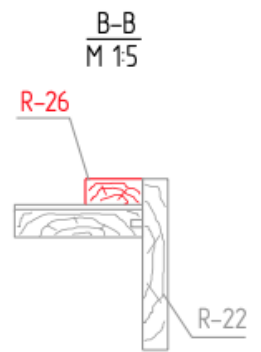
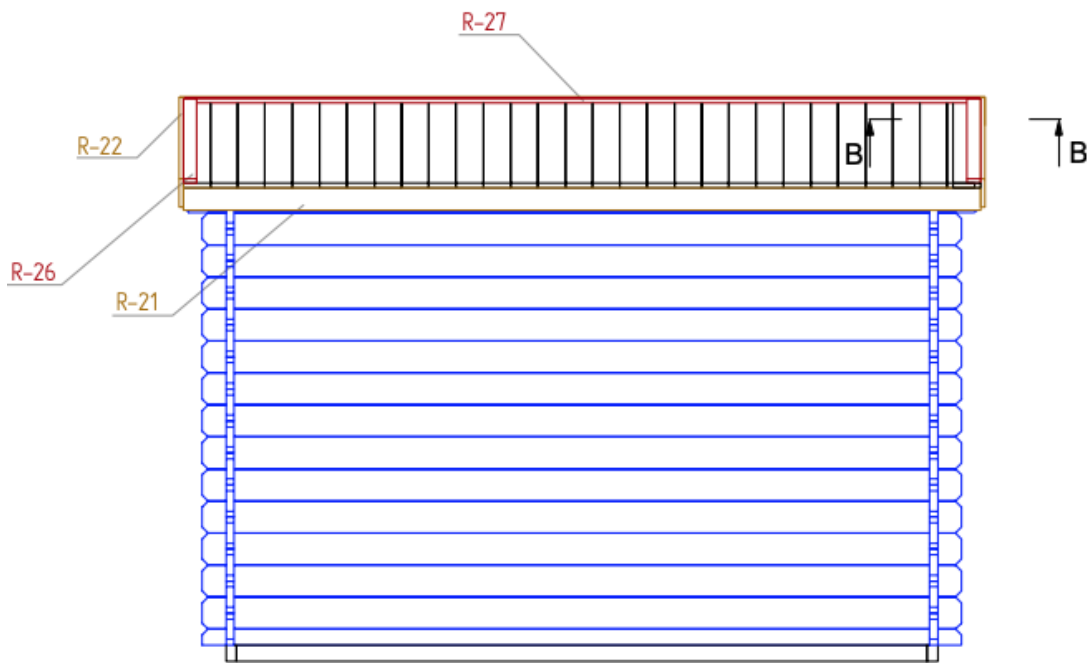
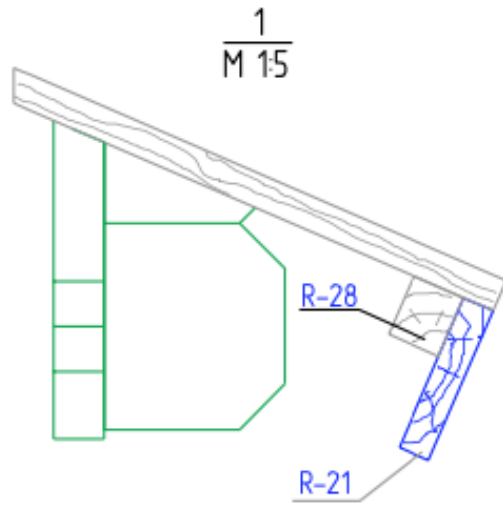

PLANIMETRIA DEI TRAVETTI

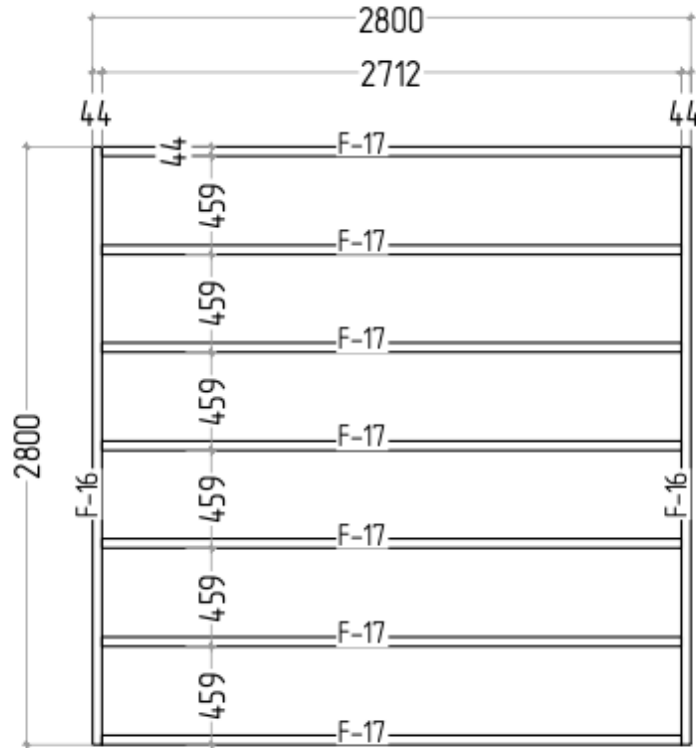

PLANIMETRIA DEL PAVIMENTO

