

DISEGNI TECNICI

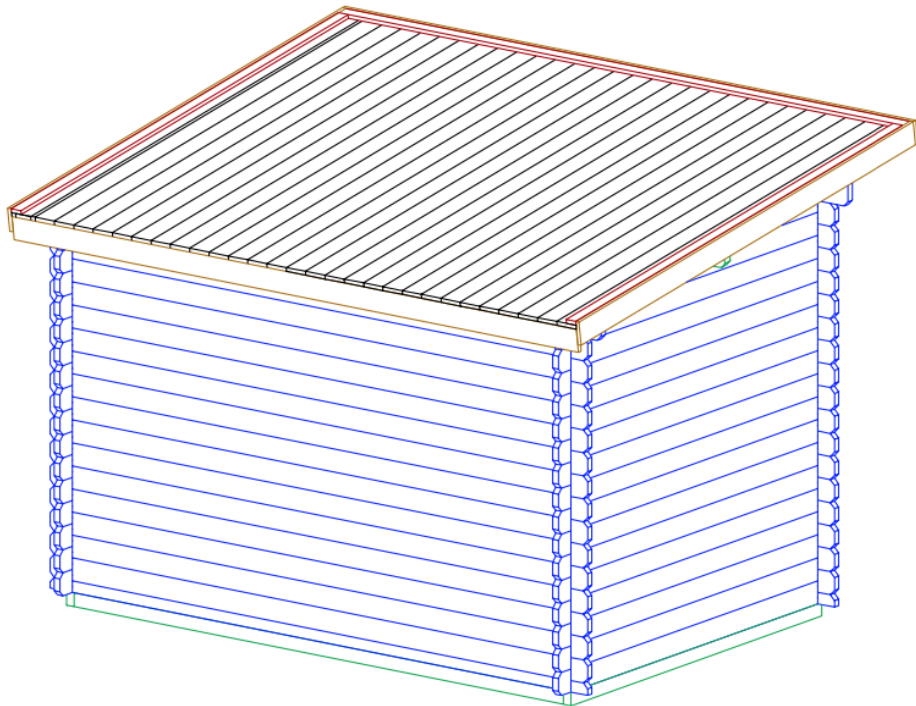

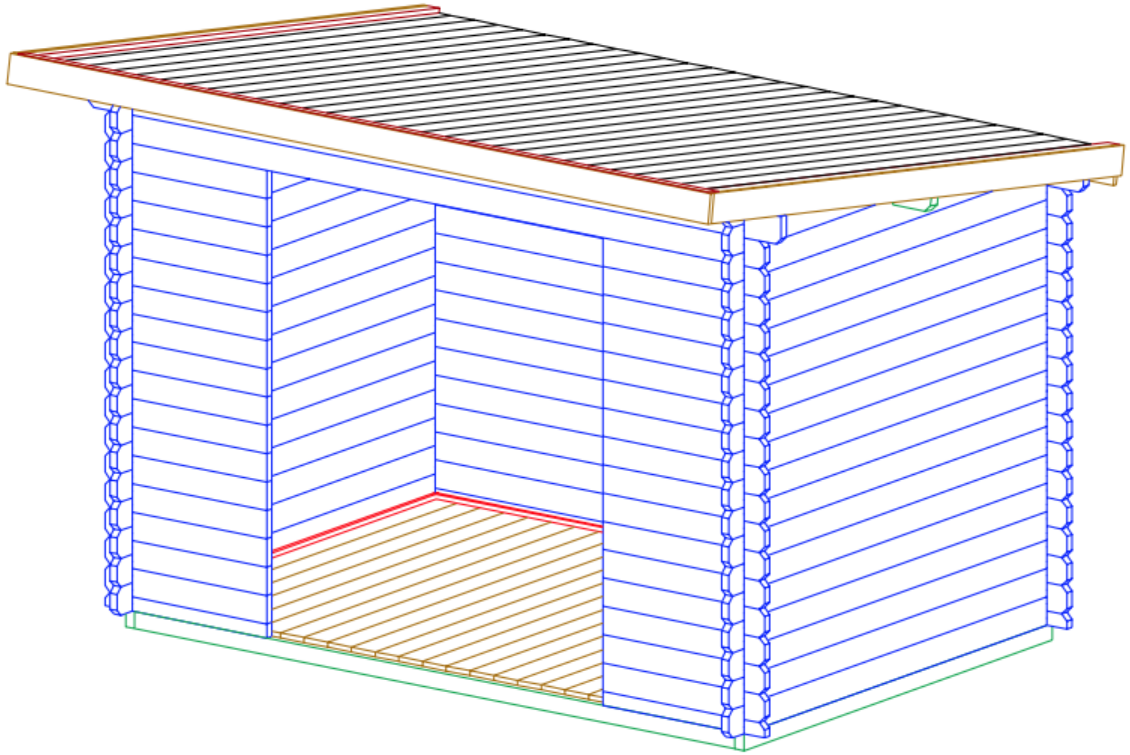

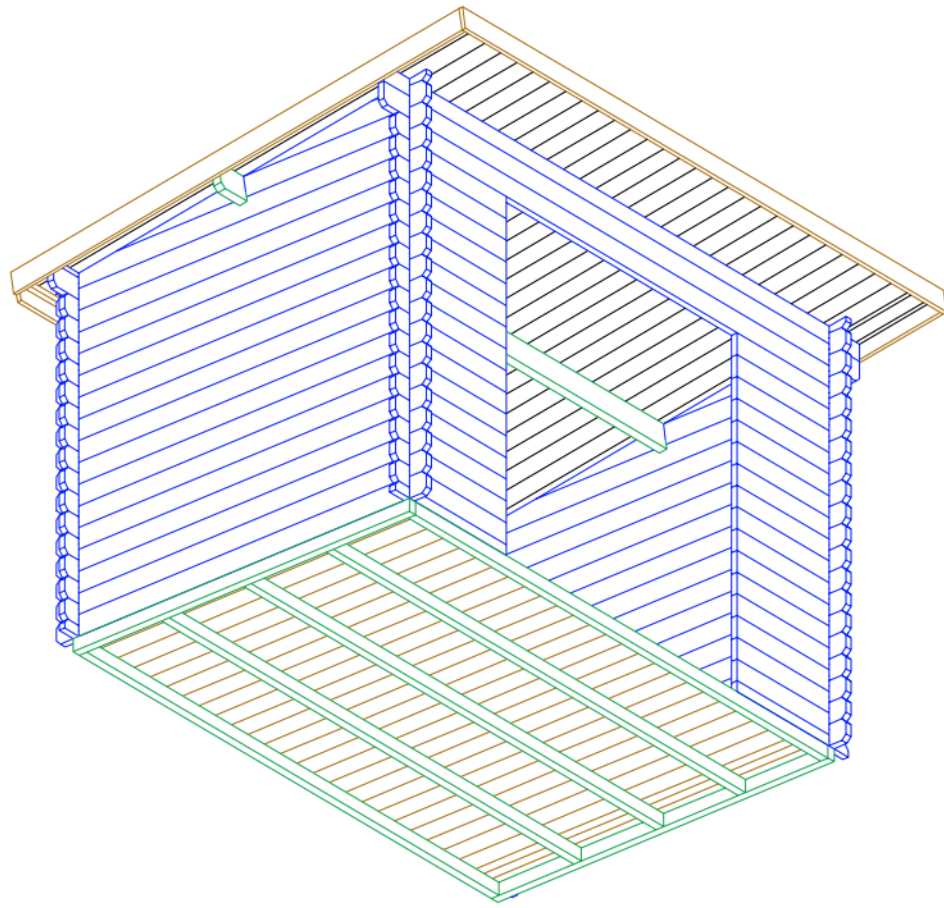
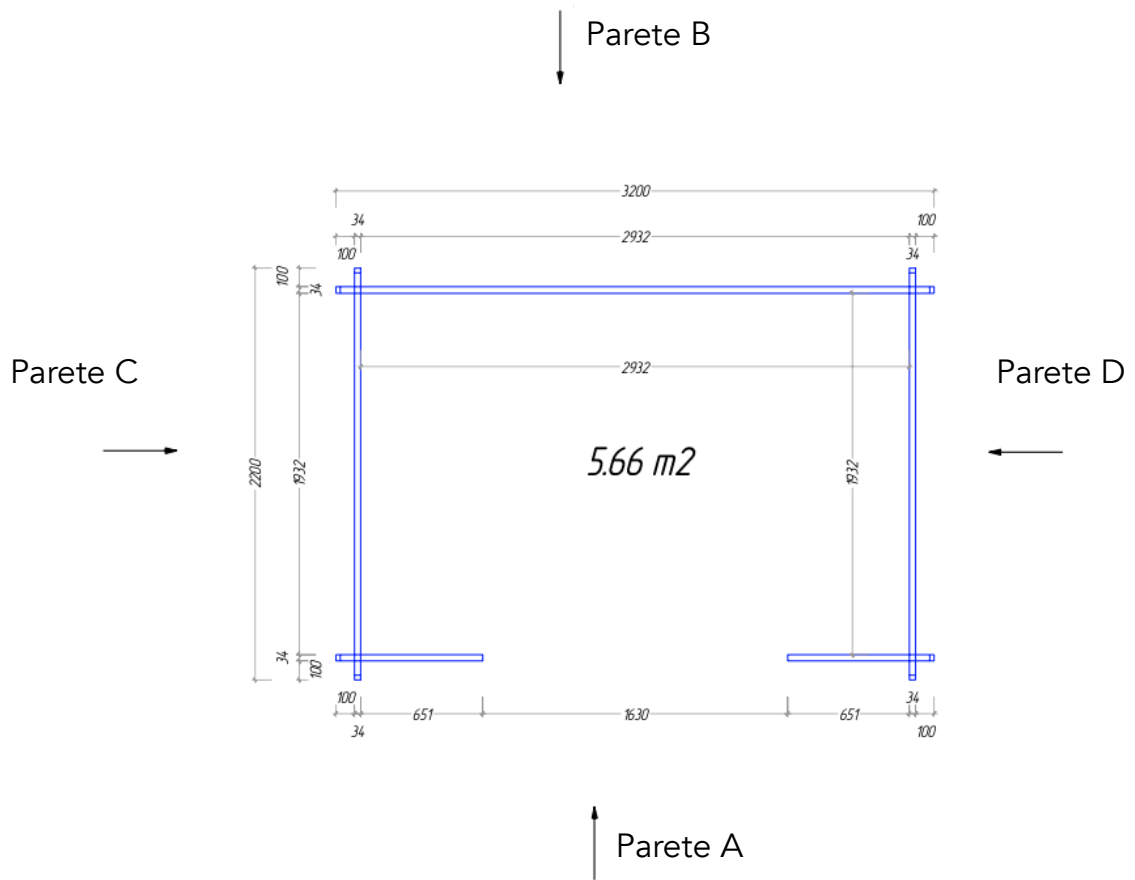

Altezza minima: 205cm
Altezza massima: 240cm
(comprensiva di travetti e tetto)

A

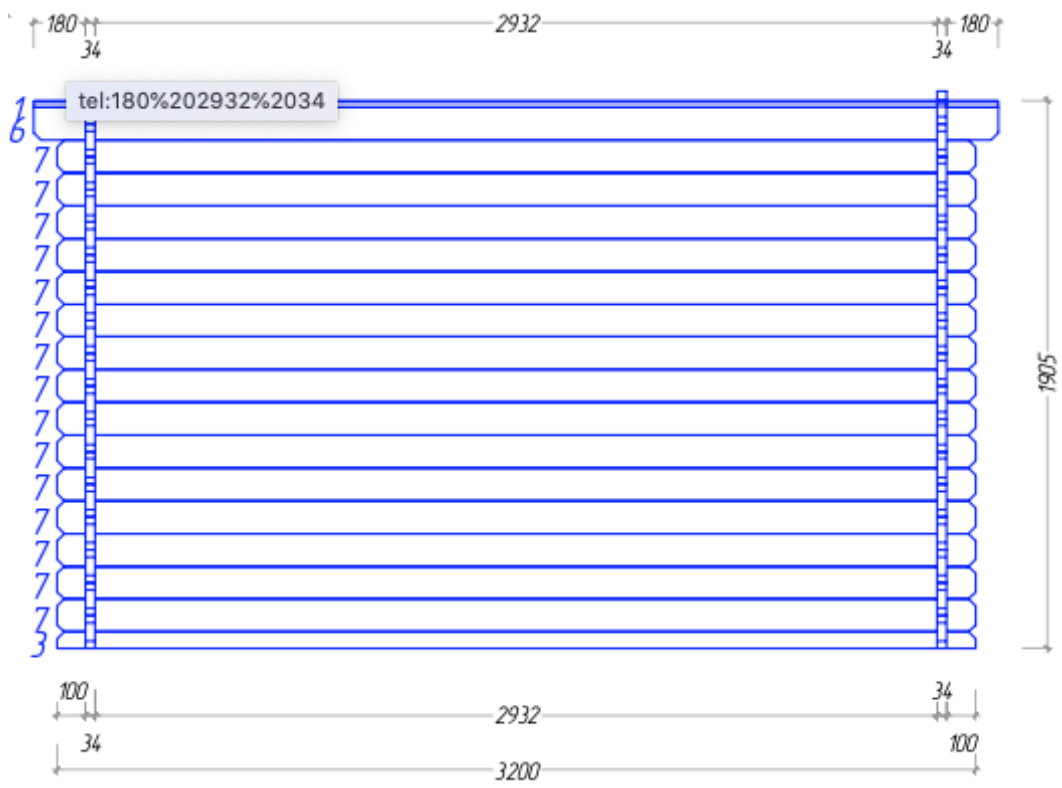
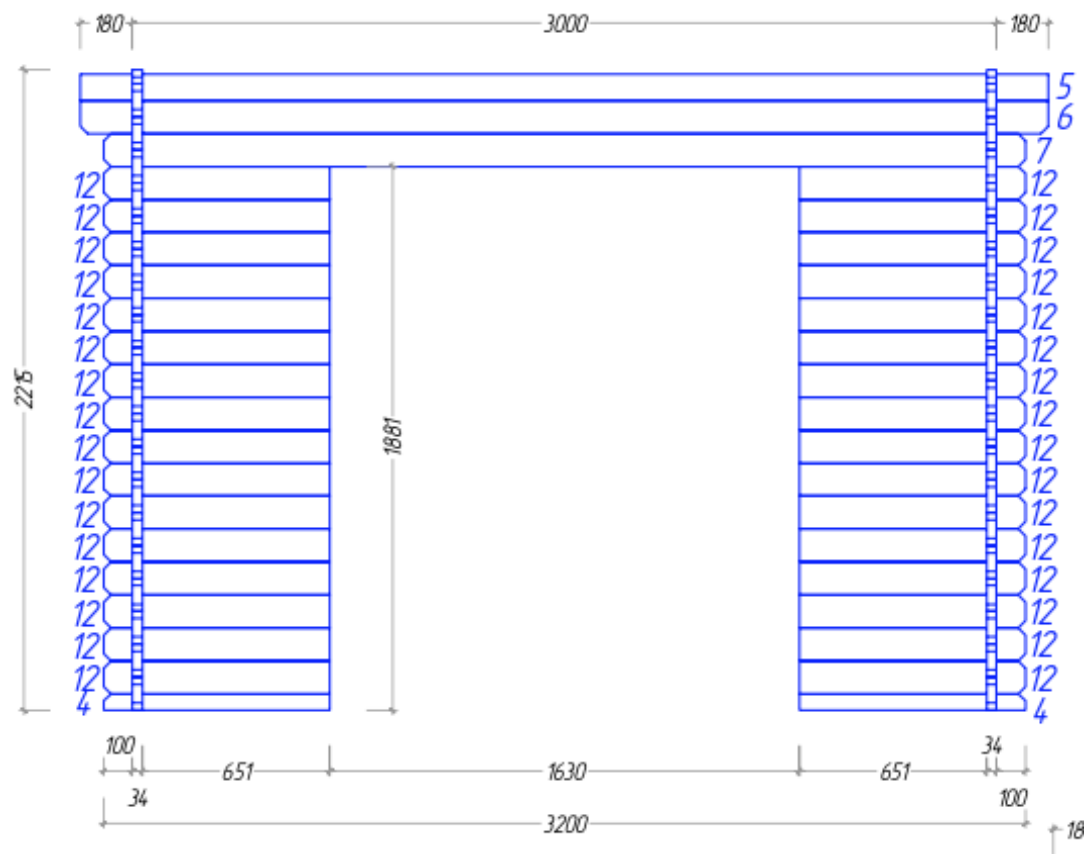

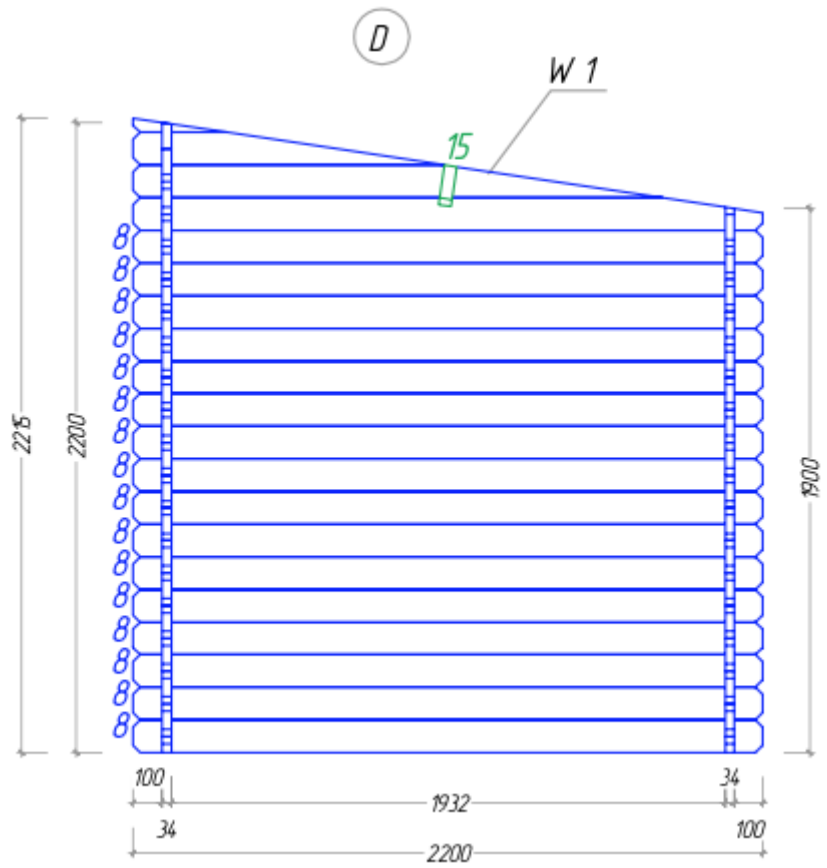
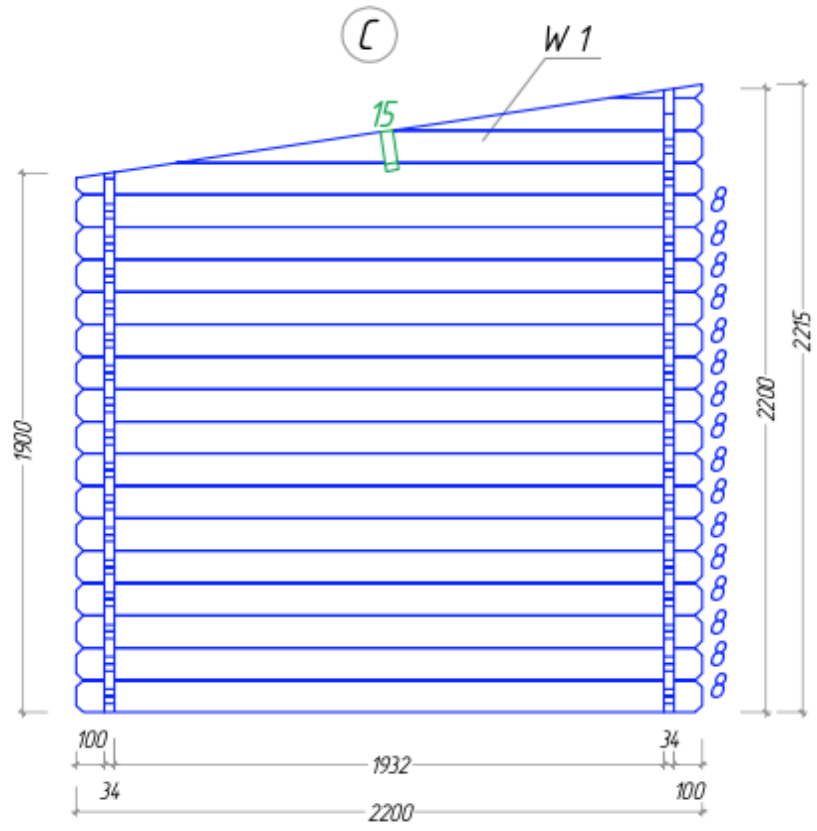

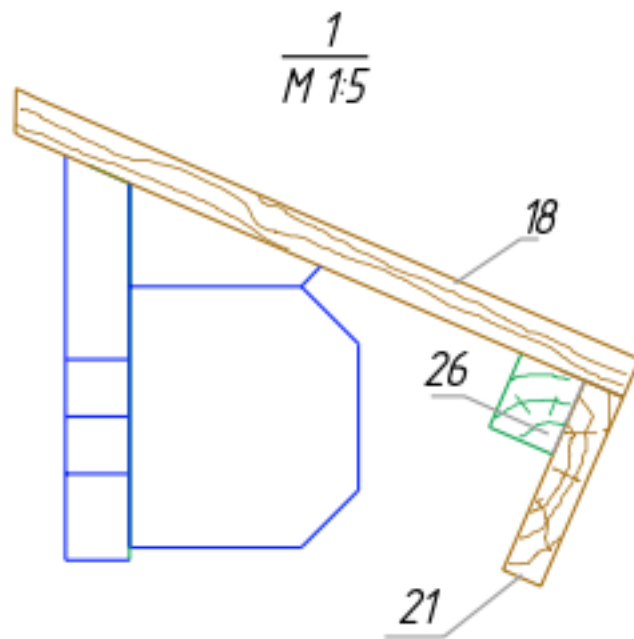
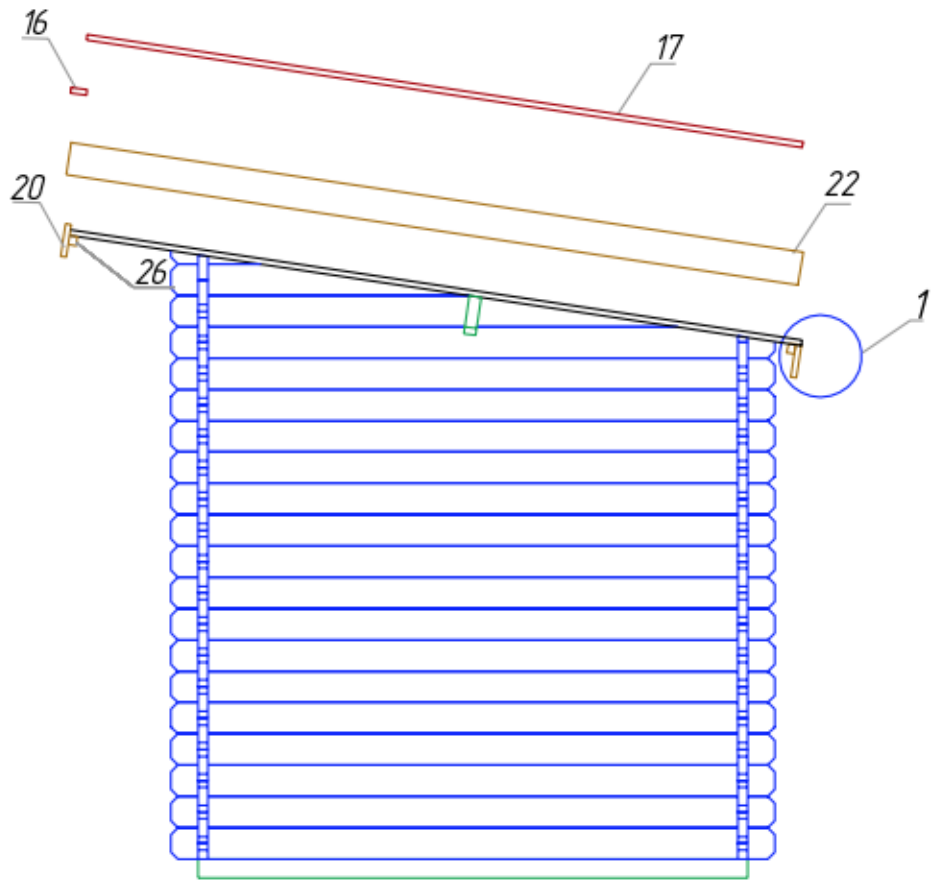

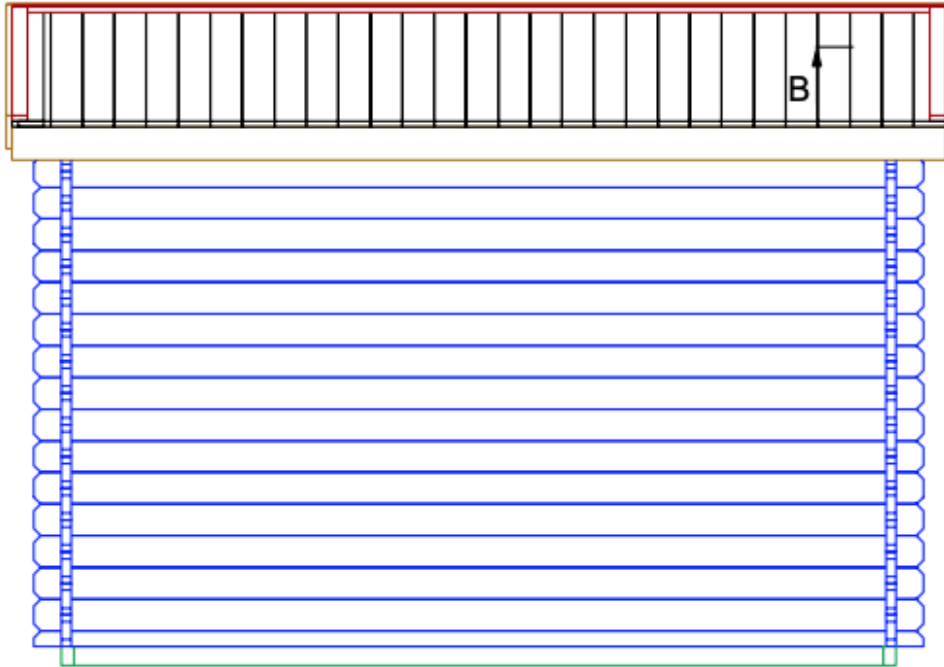

B

$\frac{B-B}{M 15}$

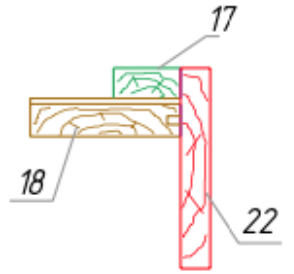

PLANIMETRIA DEI TRAVETTI

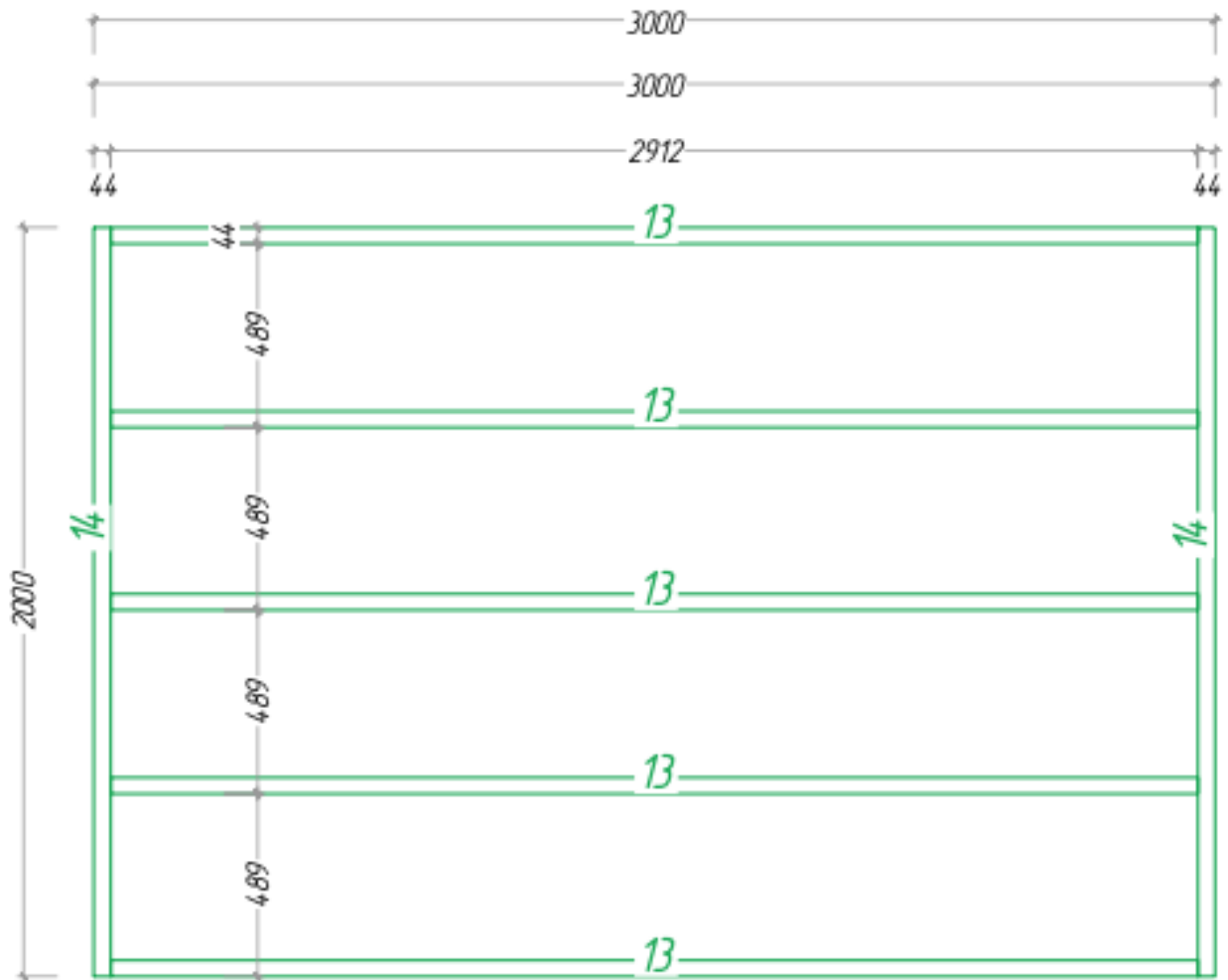

PLANIMETRIA DEL PAVIMENTO

